

# BEAT FAT

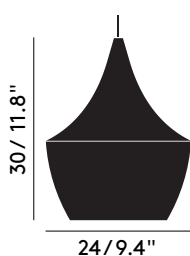

Our range of Beat lights, recognised in homes, restaurants and hotels the world over is an exercise in expressive minimalism. The design is inspired by the sculptural simplicity of traditional Indian water vessels. Available in Pendant, Table, Floor and Wall light versions.

<b>Year of Design</b>	2005
<b>Material</b>	Black – Brass; Brushed Brass; White – Brass; Grey – Silver Plated Brass
<b>Bulb Spec</b>	G9 25W (max). Bulb not included.
<b>Cable Spec</b>	250cm/98.4in black fabric cable (except Beat White which comes with white cable).



## BEAT FAT BLACK PENDANT US

**Code**  
BLS02-PUSM2

**Components**  
BLS02  
SPA12UL

## BEAT FAT BRUSHED PENDANT US

**Code**  
BLS02B-PUSM2

**Components**  
BLS02B  
SPA12UL

## BEAT FAT WHITE PENDANT US

**Code**  
BLS02WH-PUSM2

**Components**  
BLS02WH  
SPA12WUL

## BEAT FAT GREY PENDANT US

**Code**  
BLS02GR-PUSM2

**Components**  
BLS02GR  
SPA12UL

**Process**

Beat shades are formed by hand through spinning and beating techniques making each shape unique. A protective lacquer is applied to the inside surface to protect the finish.

**Cleaning Instructions**

Clean with a soft dry cloth only. Do not use polishing agents, water or abrasive materials when cleaning. Always switch off the electricity supply before cleaning.

**Country of origin**

India/China

**Packaging****SHADE**

Height	12.20 in
Width	12.20 in
Length	14.96 in
Weight	4.41 lbs

**FITTING**

Height	5.91 in
Width	6.69 in
Length	7.48 in
Weight	1.19 lbs

**Product weight**

3.43 lbs

**Dimmability**

Yes

**Certification**

UL/cUL

**Ceiling Rose Included**

Yes/Black, White

**Requires assembly**

Yes

**Recommended Megaman LED bulb**

G9 LED 3-6W (max)

Available at [tomdixontrade.net](http://tomdixontrade.net)

# BEAT FLOOR



Our range of Beat lights, recognised in homes, restaurants and hotels the world over is an exercise in expressive minimalism. The design is inspired by the sculptural simplicity of traditional Indian water vessels. Available in Pendant, Table, Floor and Wall light versions.

<b>Year of Design</b>	2013
<b>Material</b>	Brass Shade, Cast Iron Base
<b>Bulb Spec</b>	E12 40W (max). Bulb not included.
<b>Cable Spec</b>	200 cm/ 78.7in black fabric cable with inline foot switch 100 cm/39.4 in from the light base.

**BEAT FLOOR BLACK US**

**Code**  
BLF01US

**BEAT FLOOR BRASS US**

**Code**  
BLF01BUS

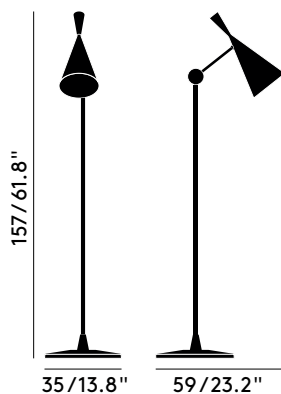

**Process**

Hand beaten and brushed brass shade with a solid brass knurled junction and a sand cast iron base.

**Cleaning Instructions**

Clean with a soft dry cloth only. Do not use polishing agents, water or abrasive materials when cleaning. Always switch off the electricity supply before cleaning.

**Country of origin**

India

**Packaging**

Height 64.17 in  
Width 20.47 in  
Length 18.50 in  
Weight 51.02 lbs

**Product weight**

27.11 lbs

**Dimmability**

Yes

**Certification**

UL/cUL

**Requires assembly**

Yes

**Recommended Megaman LED bulb**

E12 4-9W LED

Available at [tomdixontrade.net](http://tomdixontrade.net)

# BEAT STOUT



Our range of Beat lights, recognised in homes, restaurants and hotels the world over is an exercise in expressive minimalism. The design is inspired by the sculptural simplicity of traditional Indian water vessels. Available in Pendant, Table, Floor and Wall light versions.

<b>Year of Design</b>	2005
<b>Material</b>	Black – Brass; Brushed Brass; White – Brass; Grey – Silver Plated Brass
<b>Bulb Spec</b>	E26 100W (max). Bulb not included.
<b>Cable Spec</b>	250cm/98.4in black fabric cable (except Beat White which comes with white cable). Supplied with tensile wire.

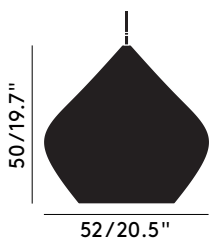

**BEAT STOUT BLACK PENDANT US**

**Code**  
BLS04-PUSM2

**Components**  
BLS04  
SPA13UL

**BEAT STOUT BRUSHED PENDANT US**

**Code**  
BLS04B-PUSM2

**Components**  
BLS04B  
SPA13UL

**BEAT STOUT WHITE PENDANT US**

**Code**  
BLS04WH-PUSM2

**Components**  
BLS04WH  
SPA13WUL

**BEAT LIGHT STOUT - GREY/SILVER**

**Code**  
BLS04GR-PUSM2

**Components**  
BLS04GR  
SPA13UL

**Process**

Beat shades are formed by hand through spinning and beating techniques making each shape unique. A protective lacquer is applied to the inside surface to protect the finish.

**Cleaning Instructions**

Clean with a soft dry cloth only. Do not use polishing agents, water or abrasive materials when cleaning. Always switch off the electricity supply before cleaning.

**Country of origin**

India/China

**Packaging****SHADE**

Height 23.23 in  
Width 23.23 in  
Length 23.23 in  
Weight 22.05 lbs

**FITTING**

Height 6.69 in  
Width 6.69 in  
Length 7.48 in  
Weight 1.43 lbs

**Product weight**

13.22 lbs

**Dimmability**

Yes

**Certification**

UL/cUL

**Ceiling Rose Included**

Yes/Black, White

**Requires assembly**

Yes

**Recommended Megaman LED bulb**

E26 LED 8-11W (max)

Available at [tomdixontrade.net](http://tomdixontrade.net)

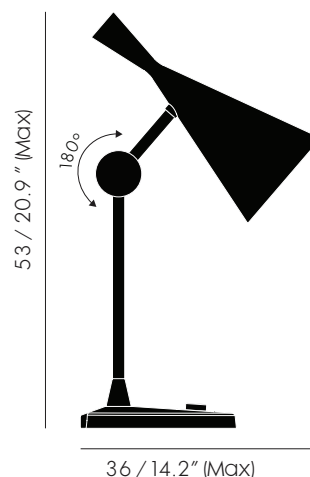

### Beat Table Black

New additions to the Beat family, inspired by the sculptural simplicity of traditional water vessels used in India. Available in black and brushed brass, as a floor or table light with a prominent on/off switch.

Process	Hand beaten brass shade, with a sprayed black exterior. Solid brass knurled junction and a sand cast iron base.
Year of Design	2014
Material	Brass, cast iron
Product Code	(EU) BLT01EU (US) BLT01US
Type	Table light
Colour	● Black
Cleaning Instructions	Clean with a soft dry cloth only. Do not use polishing agents, water or abrasive materials when cleaning. Always switch off the electricity supply before cleaning.

	Bulb spec			
	EU/UK	42W (Max) E14		
	US	40W E12 Halogen		
	Cable length	200cm / 78.7in		
	Cable colour	Black		
	Dimmer switch	On base		
	Packaging (m)	H	W	D
	BLT01EU	0.60	0.40	0.35
	Weight (kg)			
	BLT01EU	8		
	Dimensions (cm/in)			
	Ø 36cm / 14.2in			
	H 53cm / 20.9in			

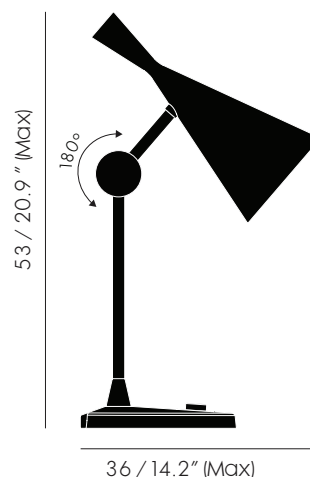

### Beat Table Brass

New additions to the Beat family, inspired by the sculptural simplicity of traditional water vessels used in India. Available in black and brushed brass, as a floor or table light with a prominent on/off switch.

Process	Hand beaten and brushed brass shade with a solid brass knurled junction and a sand cast iron base.
Year of Design	2014
Material	Brass, cast iron
Product Code	(EU) BLT01BEU (US) BLT01BUS
Type	Table light
Colour	● Brass ● Black
Cleaning Instructions	Clean with a soft dry cloth only. Do not use polishing agents, water or abrasive materials when cleaning. Always switch off the electricity supply before cleaning.

	Bulb spec			
	EU/UK	30w (max) E14 Halogen		
	US	40W E12 Halogen		
	Cable length	200cm / 78.7in		
	Cable colour	Black		
	Dimmer switch	On base		
	Packaging (m)	H	W	D
	BLT01BEU	0.60	0.40	0.35
	Weight (kg)			
	BLT01BEU	8		
	Dimensions (cm/in)			
	Ø 36cm / 14.2in			
	H 53cm / 20.9in			



# BEAT TALL



Our range of Beat lights, recognised in homes, restaurants and hotels the world over is an exercise in expressive minimalism. The design is inspired by the sculptural simplicity of traditional Indian water vessels. Available in Pendant, Table, Floor and Wall light versions.

<b>Year of Design</b>	2005
<b>Material</b>	Black – Brass; Brushed Brass; White – Brass; Grey – Silver Plated Brass
<b>Bulb Spec</b>	G9 25W (max). Bulb not included.
<b>Cable Spec</b>	250cm/98.4in black fabric cable (except Beat White which comes with white cable).



## BEAT TALL BLACK PENDANT US

**Code**  
BLS03-PUSM2

**Components**  
BLS04GR  
SPA12UL

## BEAT TALL BRUSHED PENDANT US

**Code**  
BLS03B-PUSM2

**Components**  
BLS04GR  
SPA12UL

## BEAT TALL WHITE PENDANT US

**Code**  
BLS03WH-PUSM2

**Components**  
BLS04GR  
SPA12WUL

## BEAT LIGHT TALL GREY/SILVER PENDANT

**Code**  
BLS03GR-PUSM2

**Components**  
BLS04GR  
SPA12UL

**Process**

Beat shades are formed by hand through spinning and beating techniques making each shape unique. A protective lacquer is applied to the inside surface to protect the finish.

**Cleaning Instructions**

Clean with a soft dry cloth only. Do not use polishing agents, water or abrasive materials when cleaning. Always switch off the electricity supply before cleaning.

**Country of origin**

India/China

**Packaging****SHADE**

Height 9.45 in  
Width 9.45 in  
Length 18.90 in  
Weight 2.76 lbs

**FITTING**

Height 5.91 in  
Width 6.69 in  
Length 7.48 in  
Weight 1.19 lbs

**Product weight**

2.8 lbs

**Dimmability**

Yes

**Certification**

UL/cUL

**Ceiling Rose Included**

Yes/Black, White

**Requires assembly**

Yes

**Recommended Megaman LED bulb**

G9 LED 3-6W (max)

Available at [tomdixontrade.net](http://tomdixontrade.net)

# BEAT TALL



Our range of Beat lights, recognised in homes, restaurants and hotels the world over is an exercise in expressive minimalism. The design is inspired by the sculptural simplicity of traditional Indian water vessels. Available in Pendant, Table, Floor and Wall light versions.

<b>Year of Design</b>	2005
<b>Material</b>	Black – Brass; Brushed Brass; White – Brass; Grey – Silver Plated Brass
<b>Bulb Spec</b>	G9 25W (max). Bulb not included.
<b>Cable Spec</b>	250cm/98.4in black fabric cable (except Beat White which comes with white cable).



## BEAT TALL BLACK PENDANT US

**Code**  
BLS03-PUSM2

**Components**  
BLS04GR  
SPA12UL

## BEAT TALL BRUSHED PENDANT US

**Code**  
BLS03B-PUSM2

**Components**  
BLS04GR  
SPA12UL

## BEAT TALL WHITE PENDANT US

**Code**  
BLS03WH-PUSM2

**Components**  
BLS04GR  
SPA12WUL

## BEAT LIGHT TALL GREY/SILVER PENDANT

**Code**  
BLS03GR-PUSM2

**Components**  
BLS04GR  
SPA12UL

**Process**

Beat shades are formed by hand through spinning and beating techniques making each shape unique. A protective lacquer is applied to the inside surface to protect the finish.

**Cleaning Instructions**

Clean with a soft dry cloth only. Do not use polishing agents, water or abrasive materials when cleaning. Always switch off the electricity supply before cleaning.

**Country of origin**

India/China

**Packaging****SHADE**

Height 9.45 in  
Width 9.45 in  
Length 18.90 in  
Weight 2.76 lbs

**FITTING**

Height 5.91 in  
Width 6.69 in  
Length 7.48 in  
Weight 1.19 lbs

**Product weight**

2.8 lbs

**Dimmability**

Yes

**Certification**

UL/cUL

**Ceiling Rose Included**

Yes/Black, White

**Requires assembly**

Yes

**Recommended Megaman LED bulb**

G9 LED 3-6W (max)

Available at [tomdixontrade.net](http://tomdixontrade.net)

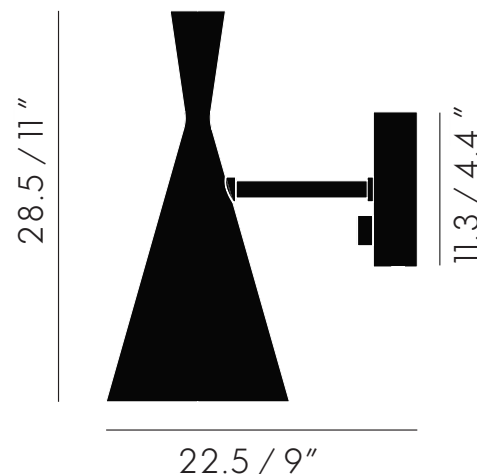

### Beat Wall Black

New addition to our much-loved Beat family, inspired by the sculptural simplicity of traditional water vessels used in India. Made from spun brass, the Beat Wall Light incorporates the familiar hand beaten shade with a solid brass dimmer dial.

Process	Beat Wall is formed of a hand beaten brass shade and brass wall bracket with a sprayed black exterior. It incorporates a knurled brass dimmer switch.
Year of Design	2014
Material	Brass
Product Code	BLW01EU
Type	Wall light
Colour	<ul style="list-style-type: none"> <li>● Brass</li> <li>● Black</li> </ul>
Cleaning Instructions	Clean with a soft dry cloth only. Do not use polishing agents, water or abrasive materials when cleaning. Always switch off the electricity supply before cleaning.

	Bulb spec	E14 40W (Max) Clear Halogen		
	EU/UK			
	Cable length	N/A		
	Cable colour	N/A		
	Dimmability	Dimmer Switch		
	Packaging (m)	H	W	D
	BLW01EU	0.22	0.3	0.4
	Weight (kg)			
	BLW01EU	1.5kg		
Dimensions (cm/in)				
H28.5cm / 11.2in				
L22.5cm / 9.0in				

# BEAT WIDE



Our range of Beat lights, recognised in homes, restaurants and hotels the world over is an exercise in expressive minimalism. The design is inspired by the sculptural simplicity of traditional Indian water vessels. Available in Pendant, Table, Floor and Wall light versions.

<b>Year of Design</b>	2005
<b>Material</b>	Black – Brass; Brushed Brass; White – Brass; Grey – Silver Plated Brass
<b>Bulb Spec</b>	G9 25W (max). Bulb not included.
<b>Cable Spec</b>	250cm/98.4in black fabric cable (except Beat White which comes with white cable).

## BEAT WIDE BLACK PENDANT US

**Code**  
BLS01-PUSM2

**Components**  
BLS01  
SPA12UL

## BEAT WIDE BRUSHED PENDANT US

**Code**  
BLS01B-PUSM2

**Components**  
BLS01B  
SPA12UL

## BEAT WIDE WHITE PENDANT US

**Code**  
BLS01WH-PUSM2

**Components**  
BLS01WH  
SPA12WUL

## BEAT LIGHT WIDE - GREY/SILVER

**Code**  
BLS01GR-PUSM2

**Components**  
BLS01GR  
SPA12UL

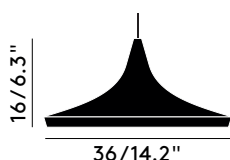

**Process**

Beat shades are formed by hand through spinning and beating techniques making each shape unique. A protective lacquer is applied to the inside surface to protect the finish.

**Cleaning Instructions**

Clean with a soft dry cloth only. Do not use polishing agents, water or abrasive materials when cleaning. Always switch off the electricity supply before cleaning.

**Country of origin**

India/China

**Packaging****SHADE**

Height 16.54 in  
Width 16.54 in  
Length 9.45 in  
Weight 4.85lbs

**FITTING**

Height 5.91 in  
Width 6.69 in  
Length 7.48 in  
Weight 1.19 lbs

**Product weight**

4.36 lbs

**Dimmability**

Yes

**Certification**

UL/cUL

**Ceiling Rose Included**

Yes/Black, White

**Requires assembly**

Yes

**Recommended Megaman LED bulb**

G9 LED 3-6W (max)

Available at [tomdixontrade.net](http://tomdixontrade.net)

# BEAT FLAT



Our range of Beat lights, recognised in homes, restaurants and hotels the world over is an exercise in expressive minimalism. The design is inspired by the sculptural simplicity of traditional Indian water vessels. Available in Pendant, Table, Floor and Wall light versions.

## BEAT FLAT BLACK PENDANT UL

**Code**  
BLS06-PUSM1

**Components**  
BLS06  
SPA13UL

**Year of Design** 2016  
**Material** Brass

**Bulb Spec** E27 42W (max). Bulb not included.  
**Cable Spec** 250m/98.4in black fabric cable. Supplied with tensile wire.

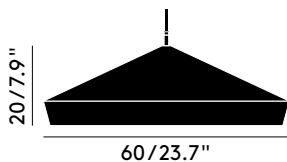



**Process**

Formed by hand through an intensive technique of spinning and metal beating. A protective lacquer is applied to the inside surface to protect and fix the finish. A dark patina is then applied at the end of production.

**Cleaning Instructions**

Clean with a soft dry cloth only. Do not use polishing agents, water or abrasive materials when cleaning. Always switch off the electricity supply before cleaning

**Country of origin**

India

**Packaging****SHADE**

Height	10.62 in
Width	25.59 in
Length	25.59 in
Weight	17.19 lbs

**FITTING**

Height	6.69 in
Width	6.69 in
Length	7.48 in
Weight	1.43 lbs

**Product weight**

7.84 lbs

**Dimmability**

Mains dimmable  
(depending on lamp application)

**Ceiling Rose Included (colour/material)**

Black/Powder Coated Metal  
4.9 in

**Recommended LED bulb**

E27 LED

Available at [tomdixontrade.net](http://tomdixontrade.net)

# BEAT WAIST



Our range of Beat lights, recognised in homes, restaurants and hotels the world over is an exercise in expressive minimalism. The design is inspired by the sculptural simplicity of traditional Indian water vessels. Available in Pendant, Table, Floor and Wall light versions.

## BEAT WAIST BLACK PENDANT UL

### Code

BLS05-PUSM1

### Components

BLS05

SPA13UL

**Year of Design** 2016  
**Material** Brass

**Bulb Spec** E27 42W (max). Bulb not included.  
**Cable Spec** 250m/98.4in clear cable. Supplied with a tensile wire.

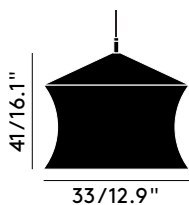

**Process**

Formed by hand through an intensive technique of spinning and metal beating. A protective lacquer is applied to the inside surface to protect and fix the finish. A dark patina is then applied at the end of production.

**Cleaning Instructions**

Clean with a soft dry cloth only. Do not use polishing agents, water or abrasive materials when cleaning. Always switch off the electricity supply before cleaning

**Country of origin**

India

**Packaging****SHADE**

Height	16.53 in
Width	18.89 in
Length	18.89 in
Weight	11.46 lbs

**FITTING**

Height	6.69 in
Width	6.69 in
Length	7.48 in
Weight	1.43 lbs

**Product weight**

6.61 lbs

**Dimmability**

Mains dimmable  
(depending on lamp application)

**Ceiling Rose Included (colour/material)**

Black/Powder Coated Metal  
4.9 in

**Recommended LED bulb**

E27 LED

Available at [tomdixontrade.net](http://tomdixontrade.net)